

Lecture 23

Optical MEMS (5)

■ Agenda:

- MEMS in Optical Communications

MEMS in Optical Communication Systems

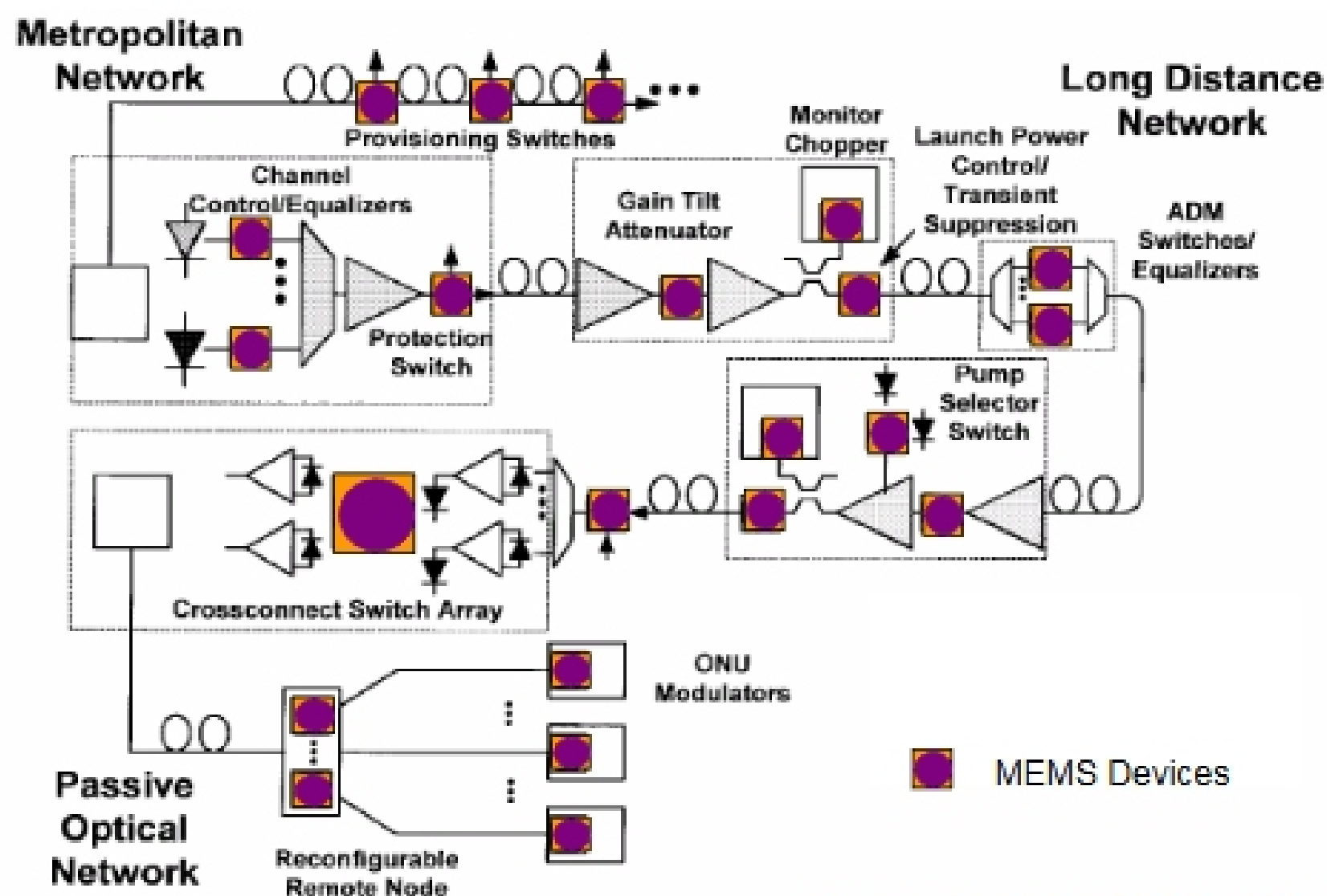

Giles et al., IEEE J. STQE, 1999

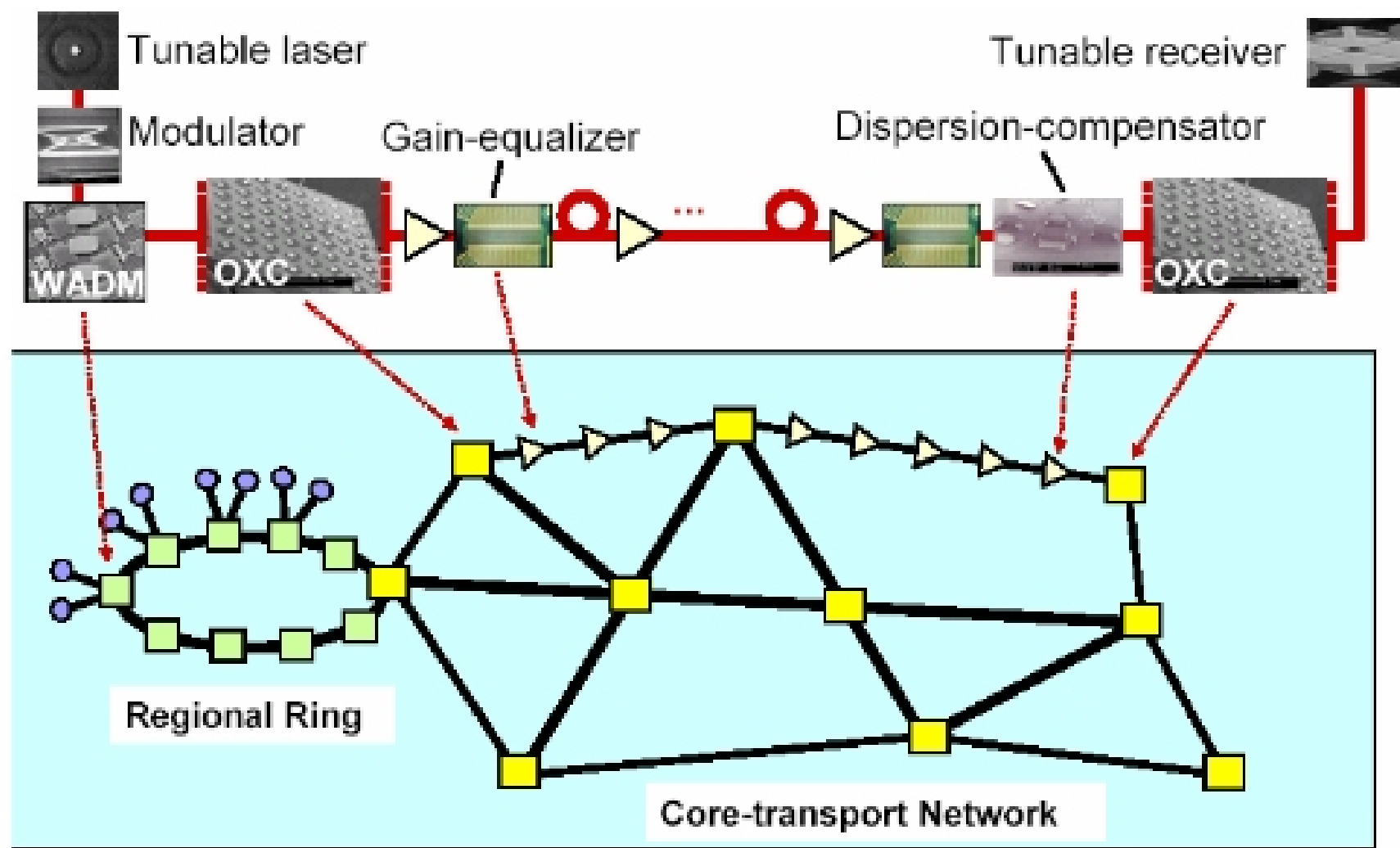

L. Y. Lin (U-Washington)

- **Provisioning Switches**
- **Protection Switches**
- **Equalizers**
- **Cross-connect Switches**
- **Variable Attenuators**
- **Filters**
- **Modulators**
- **Add/Drop Multiplexers**
- **VCSELs**

Tilt Micromirror

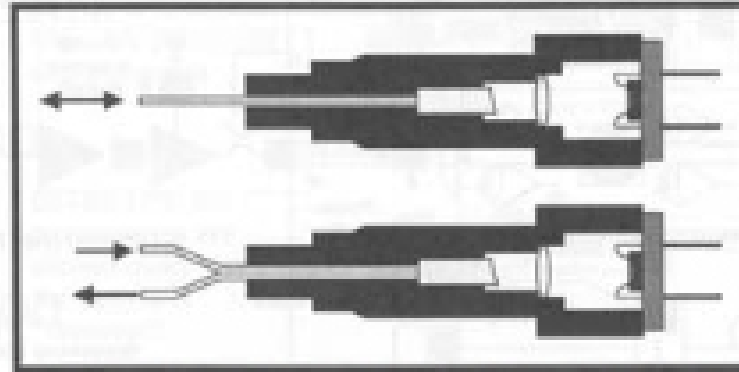
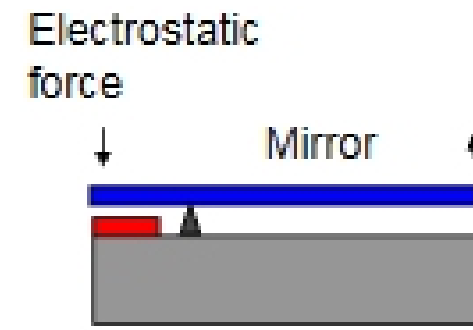
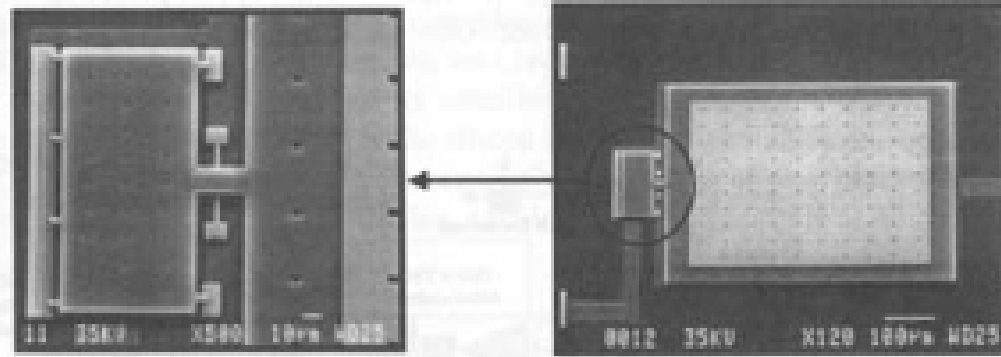

One and two fiber coaxial packages

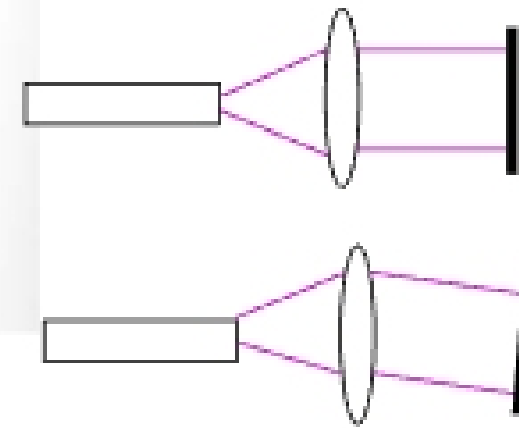

Tilt Micromirror Array

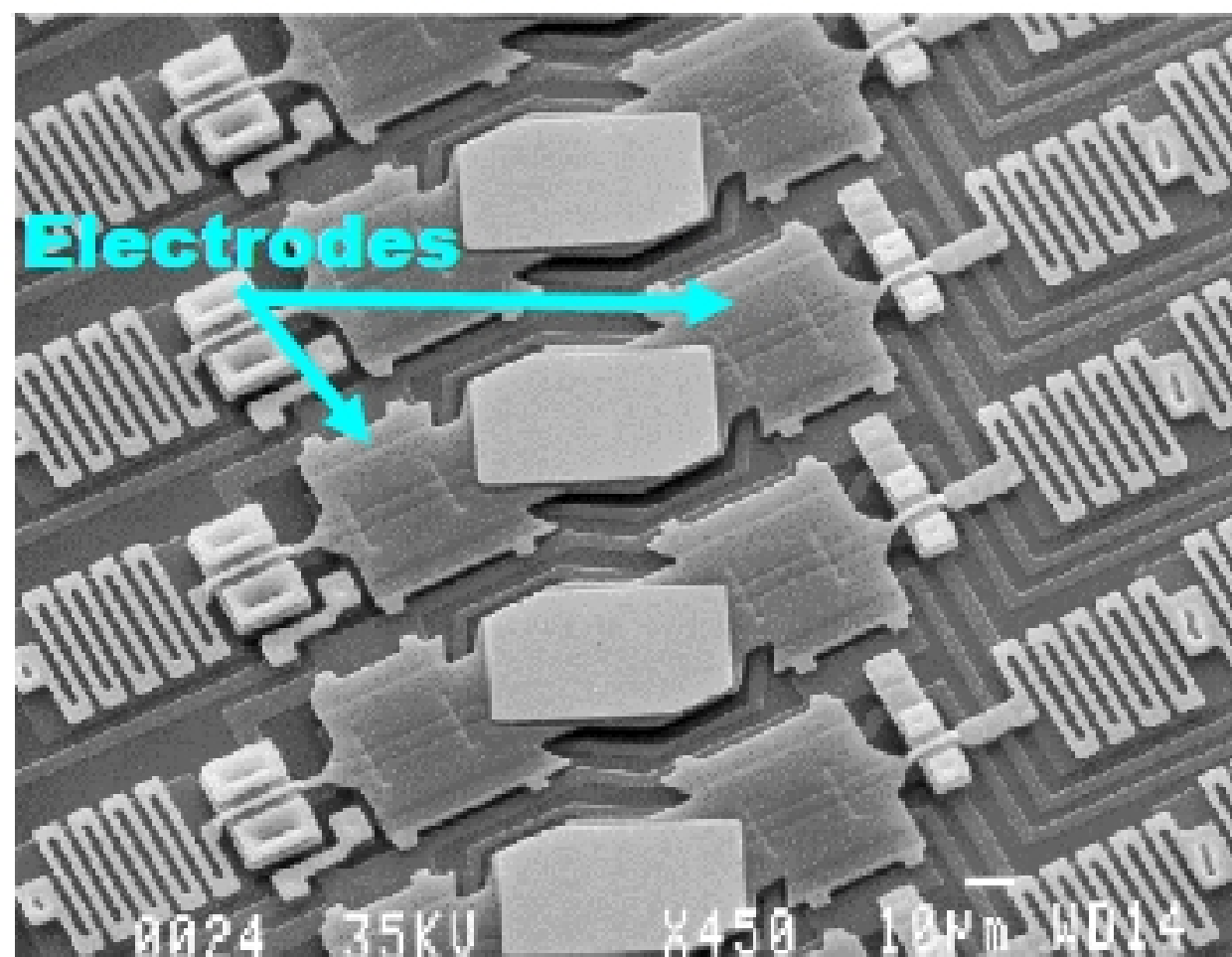

For Add/Drop Multiplexer (Lucent)